

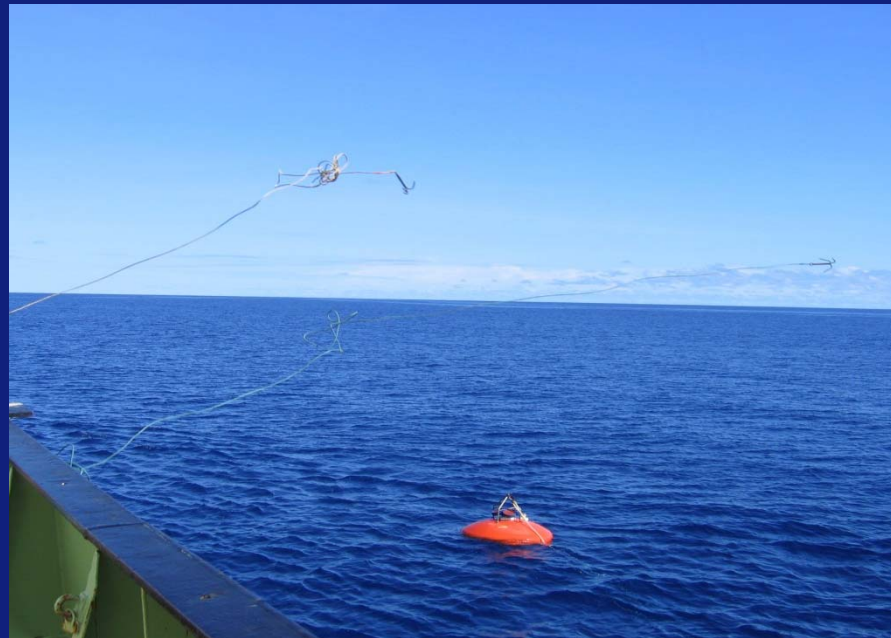

Koninklijk Nederlands Instituut voor Zeeonderzoek

Usefull Small Tools



By Marck Smit & Jack Schilling



“Trekologum”, a tool for connecting and disconnecting core barrels.





Mooring Cable Stopper





Adjustable Mooring Cable Stopper

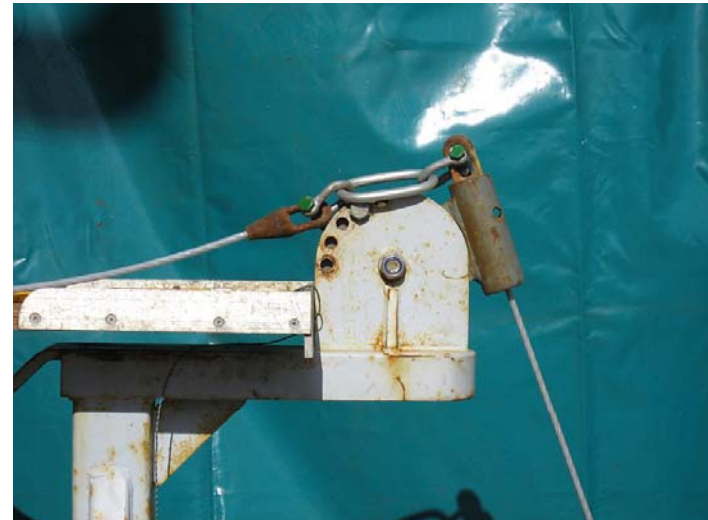



Quick Releases

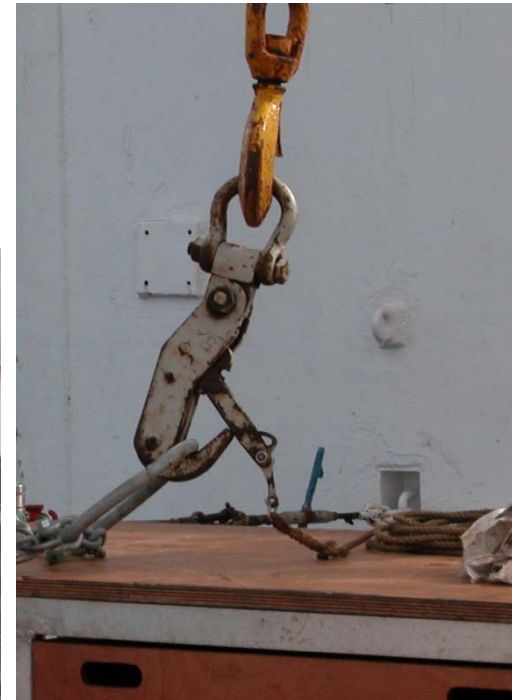



Sea Catch Quick Releases

Sea Catch Products

(Click on an image for more details)

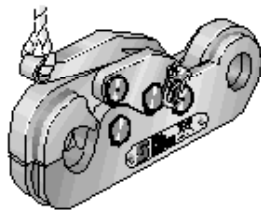

**Sea Catch Models
& Specifications**

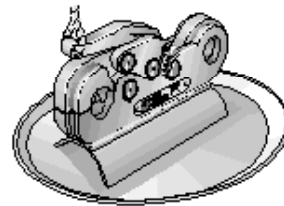

**Sea Catch TR7S
Skiff Release**

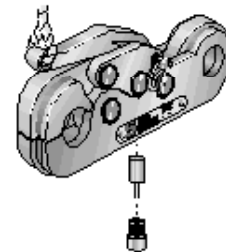

Squib-fired Units

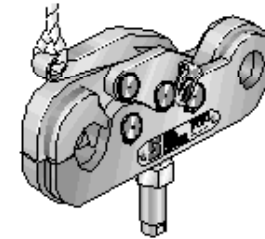

Hydraulic-activated Units

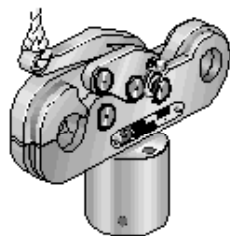

Air-activated Units

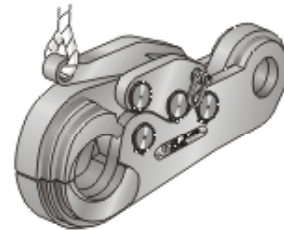

Sea Catch "LM" Series

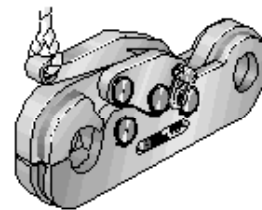

Sea Catch TR18



**Sea
Catch
Retrieving
Hook**



**Sea
Catch
Offload
Hook**

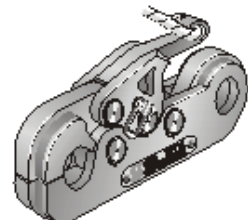

**Sea Catch TR7RL
(Reverse Lever)**



Wide Body Mooring block





Wide Body Mooring Block

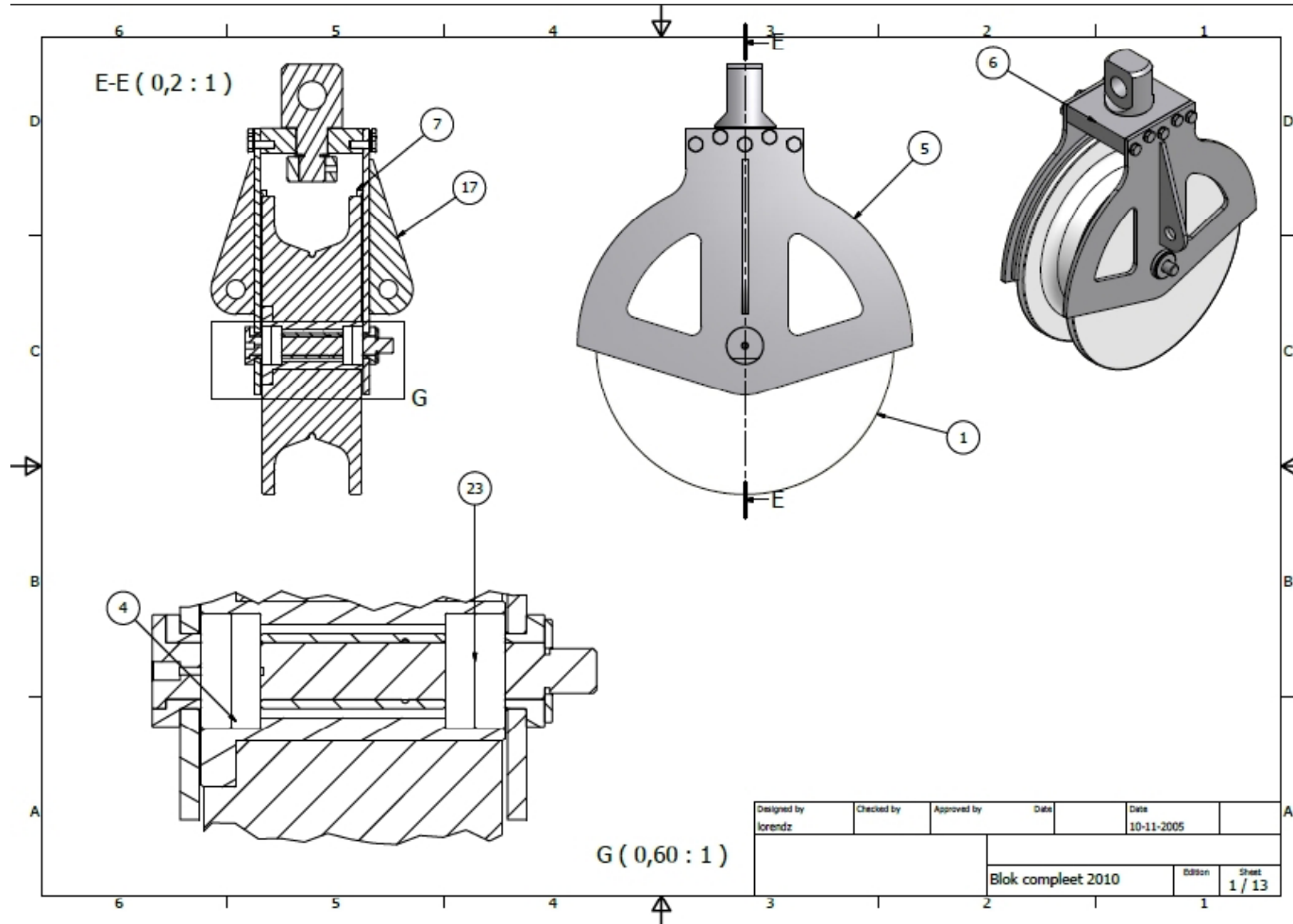



Lathe For Liners (male/female)

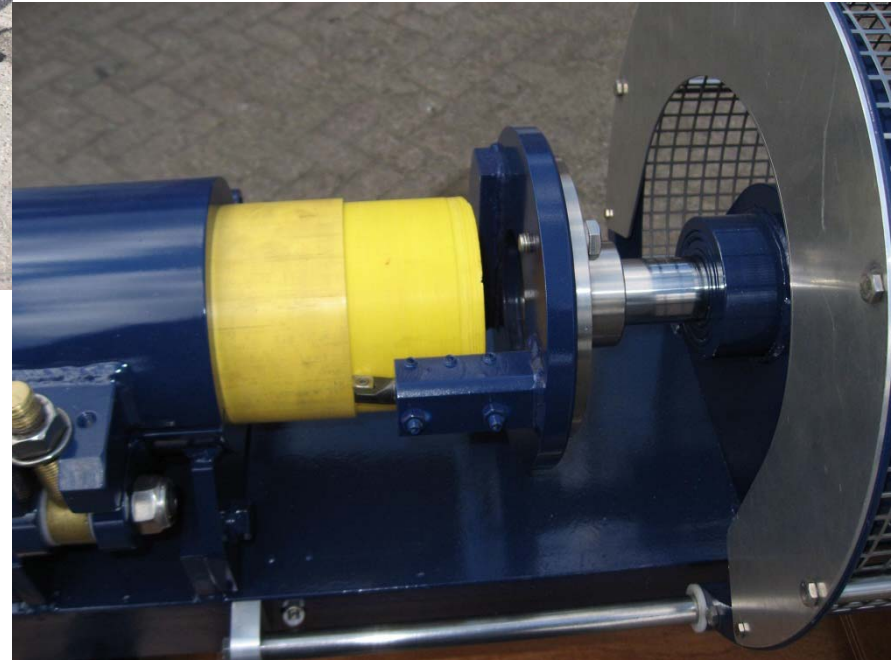



End Termination for NIOZ Super Aramid Cable

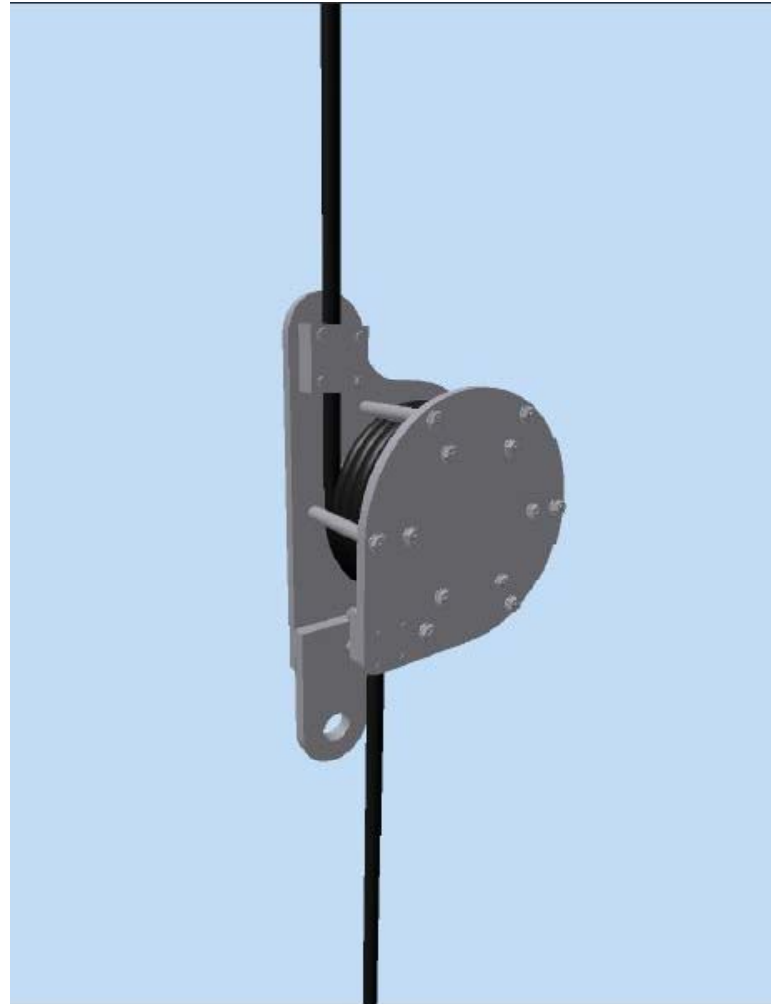



End Termination for NIOZ Super Aramid Cable

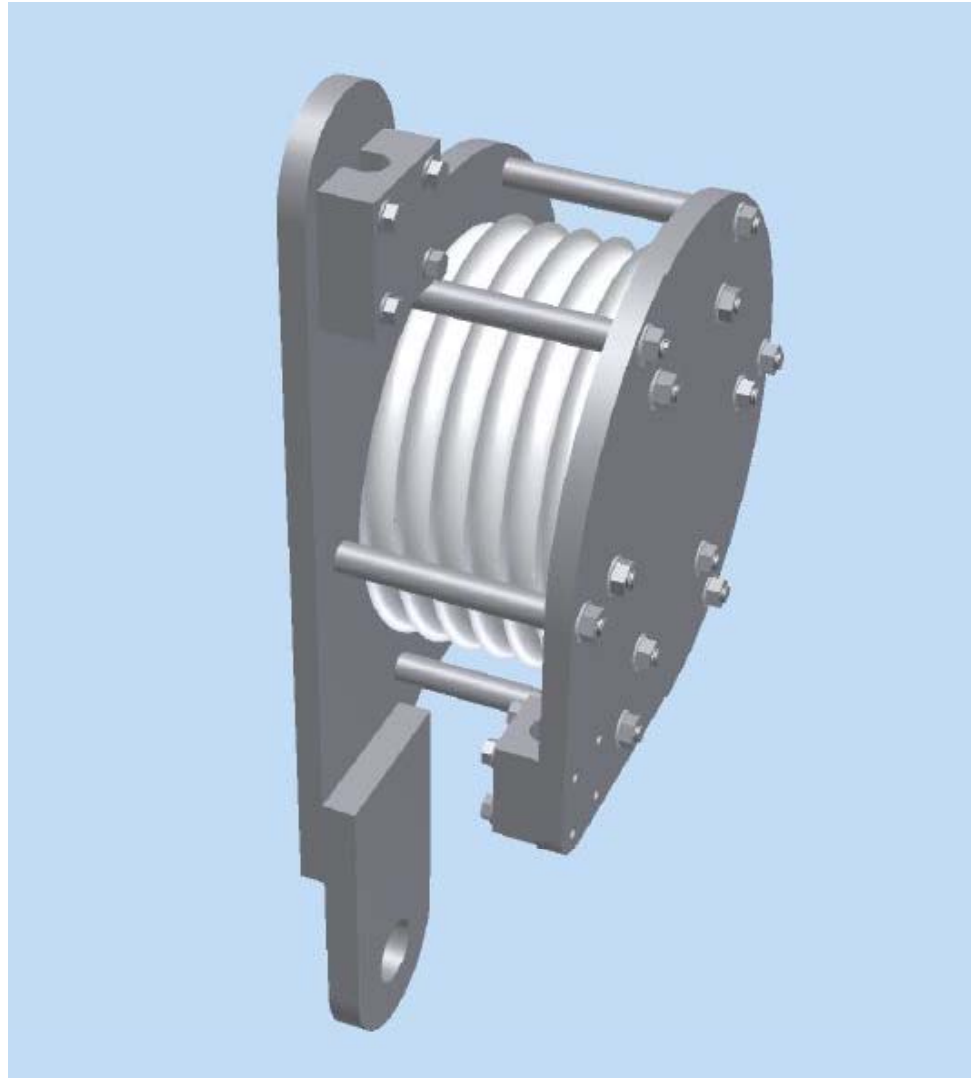



INMARTECH 2012 at NIOZ Texel

- Target group:
 - Marine Techs
 - OFEG-TECH attendees-alike
 - RV-tech alike
 - Etc!!!!
- Subjects:
 - Moorings and Bottom Landers
 - Cables and winches
 - Shipboard operations
 - Lab containers
 - ROV/AUV/gliders: new developments/
new instrumentation
 - Instrument development
 - **Tips and tricks**
 - **Lessons learned**
- Setting:
 - Focus on informal interaction
 - Where possible:
 - In the workshop
 - around equipment,
instruments or posters





Input from you!!!!

- Talks
- Suggested speakers
- Suggested subjects

- Suggestions/remarks



For your agenda's!!

Preliminary dates:

26/27/28 September 2012

Combine with OFEG-TECH 2012!

24+25 Sep 2012



Koninklijk Nederlands Instituut voor Zeeonderzoek

Thank you for your attention

Questions?